

This drawing is the property of PLB Vindic AB. It is strictly confidential and must not be copied, traced or loaned without permission. Any infringement of these conditions will lead to the institution of legal procedures

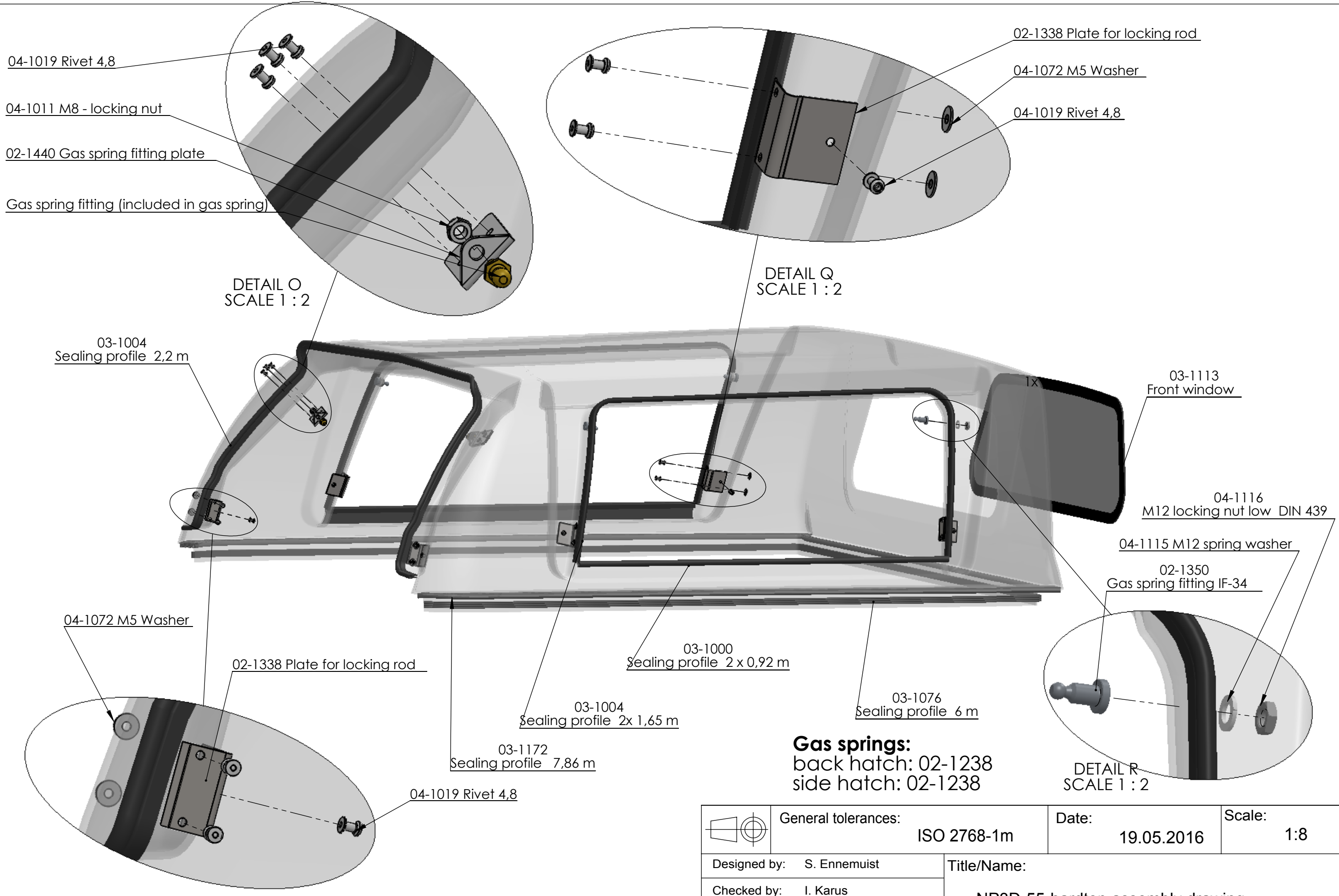



Gas springs:
back hatch: 02-1238
side hatch: 02-1238

	General tolerances:	ISO 2768-1m	Date:	19.05.2016	Scale:	1:8
	Designed by:	S. Ennemuist	Title/Name:			
Checked by:	I. Karus	NP3D-55-hardtop assembly drawing				
Owner:	 PLB Vindic AB Sweden	Sheet: 1/1	Drawing number:			NP3D-01.201

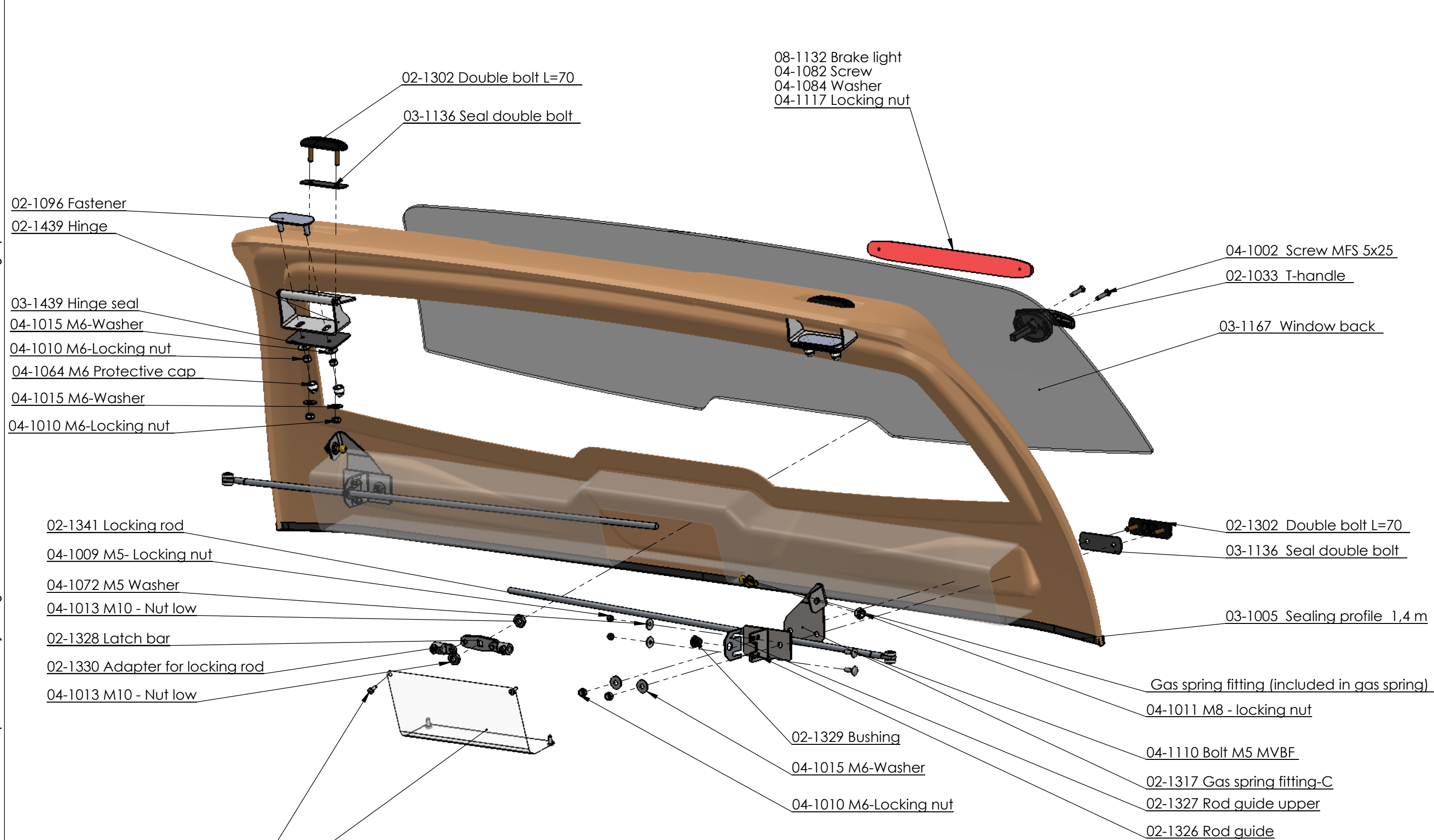

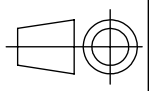
This drawing is the property of PLB Vindic AB. It is strictly confidential and must not be copied, traced or loaned without permission. Any infringement of these conditions will lead to the institution of legal procedures

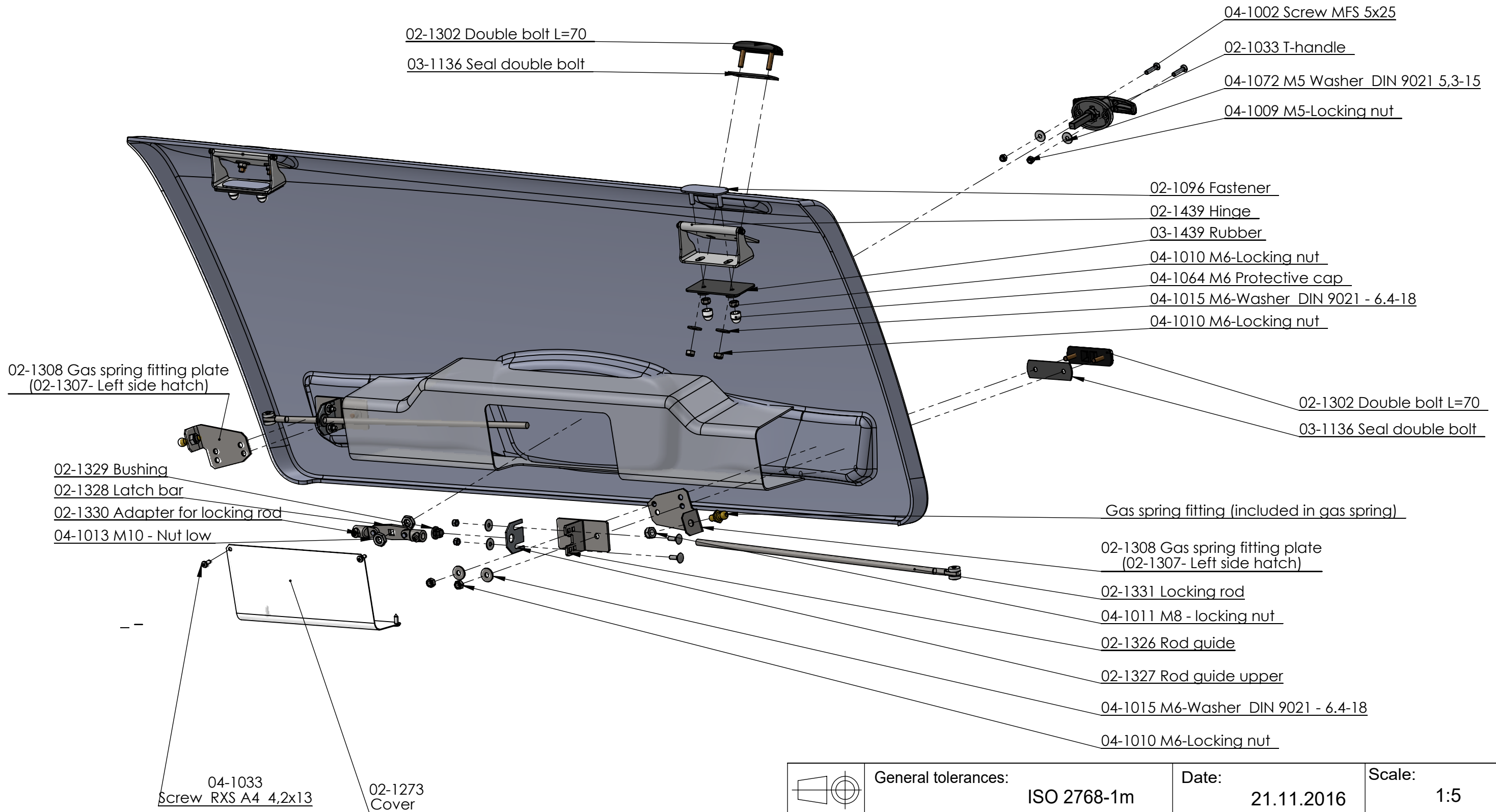

	General tolerances:	ISO 2768-1m	Date:	28.02.2017	Scale:	1:5
	Designed by:	S. Ennemuist	Title/Name:			
Checked by:	I. Karus	NP3D-55, NP3D-0, NP3K-55 and NP3K-0 back hatch assembly drawing				
Owner:	 PLB Vindic AB Sweden		Sheet: 1/1	Drawing number:		NP3D-03.201

This drawing is the property of PLB Vindic AB. It is strictly confidential and must not be copied, traced or loaned without permission. Any infringement of these conditions will lead to the institution of legal procedures

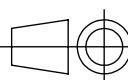

	General tolerances:	ISO 2768-1m	Date:	21.11.2016	Scale:	1:5
	Designed by:	S. Ennemuist		Title/Name:		
Checked by:	I. Karus		NP3D-55 side hatch assembly drawing			
Owner:	 PLB Vindic AB Sweden		Sheet: 1/1	Drawing number:		
			NP3D-02.201			