

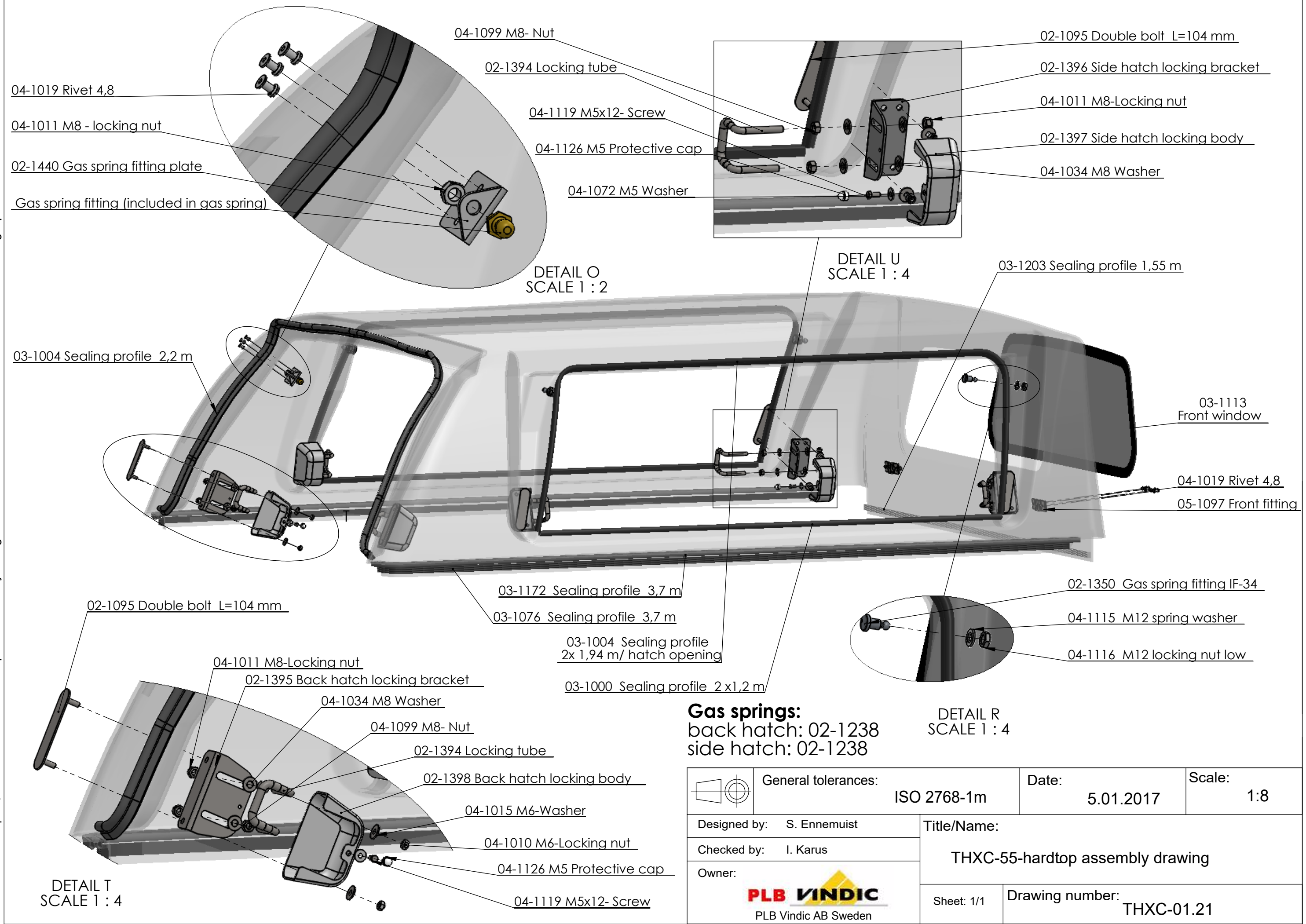

This drawing is the property of PLB Vindic AB. It is strictly confidential and must not be copied, traced or loaned without permission. Any infringement of these conditions will lead to the institution of legal procedures

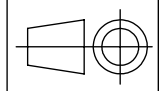

**Gas springs:**  
 back hatch: 02-1238  
 side hatch: 02-1238

|   |   |              |                                  |                            |        |     |
|---|---|--------------|----------------------------------|----------------------------|--------|-----|
|  | General tolerances:   | ISO 2768-1m  | Date:                            | 5.01.2017                  | Scale: | 1:8 |
|   | Designed by:  | S. Ennemuist |                                  | Title/Name:                |        |     |
| Checked by:   | I. Karus  |              | THXC-55-hardtop assembly drawing |                            |        |     |
| Owner:  | <br>PLB Vindic AB Sweden |              | Sheet: 1/1                       | Drawing number: THXC-01.21 |        |     |

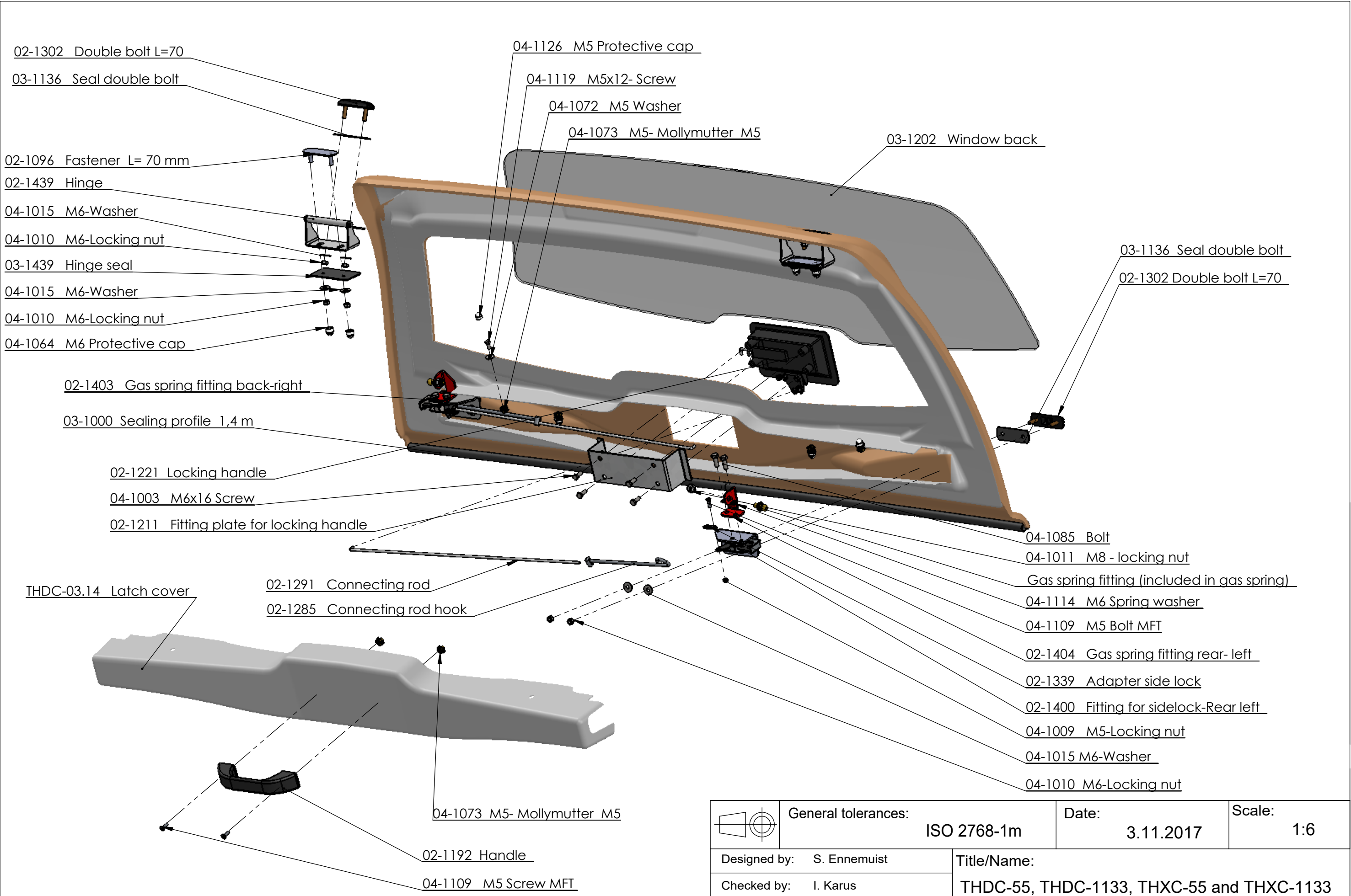

This drawing is the property of PLB Vindic AB. It is strictly confidential and must not be copied, traced or loaned without permission. Any infringement of these conditions will lead to the institution of legal procedures

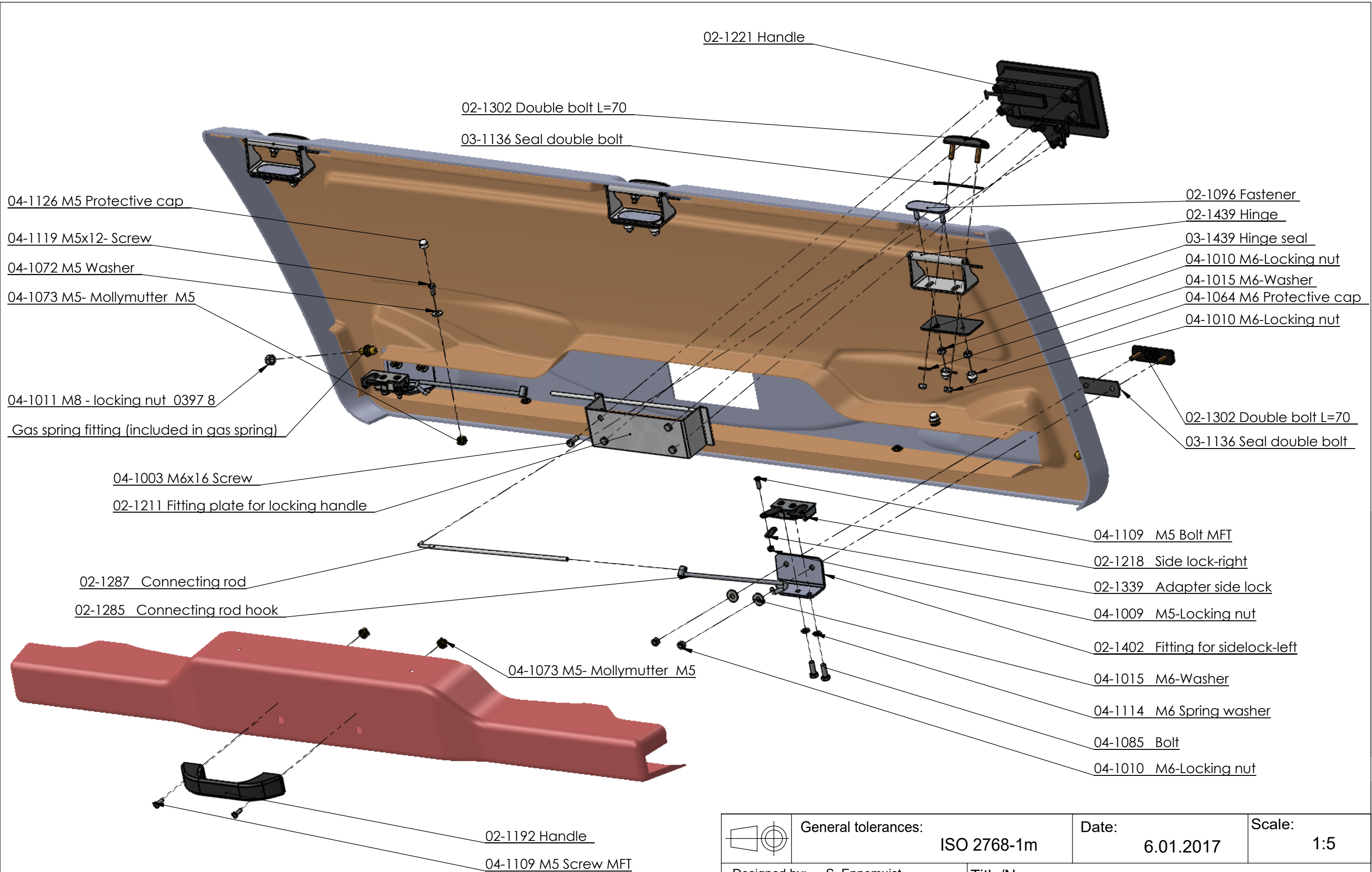

|             |                          |   |             |                 |        |            |
|-------------|--------------------------|---|-------------|-----------------|--------|------------|
|             | General tolerances:      | ISO 2768-1m   | Date:       | 3.11.2017       | Scale: | 1:6        |
|             | Designed by:             | S. Ennemuist  | Title/Name: |                 |        |            |
| Checked by: | I. Karus                 | THDC-55, THDC-1133, THXC-55 and THXC-1133 back hatch assembly drawing |             |                 |        |            |
| Owner:      | <br>PLB Vindic AB Sweden |   | Sheet: 1/1  | Drawing number: |        | THDC-03.21 |

This drawing is the property of PLB Vindic AB. It is strictly confidential and must not be copied, traced or loaned without permission. Any infringement of these conditions will lead to the institution of legal procedures

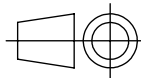

|   |   |                                     |                 |           |        |            |
|---|---|-------------------------------------|-----------------|-----------|--------|------------|
|  | General tolerances:   | ISO 2768-1m                         | Date:           | 6.01.2017 | Scale: | 1:5        |
|   | Designed by:  | S. Ennemuist                        | Title/Name:     |           |        |            |
| Checked by:   | I. Karus  | THXC-55 side hatch assembly drawing |                 |           |        |            |
| Owner:  | <br>PLB Vindic AB Sweden | Sheet: 1/1                          | Drawing number: |           |        | THXC-02.21 |